



Radionics[®]

D2071A Fire Control/Communicator
Digital Alarm Communicator Transmitter (DACT)

Installation and Programming Manual

FCC Notice

This equipment generates, uses and can radiate radio frequency energy. If not installed in accordance with the manufacturer's instructions, it may cause interference to radio communications. It has been tested and found to comply with the specifications in Subpart J of Part 15 of FCC Rules for Class B Computing Devices.

If this equipment causes interference to radio or television reception -- which can be determined by turning the equipment on and off -- the installer is encouraged to correct the interference by one or more of the following measures: 1) Reorient the antenna of the radio/television, 2) Connect the AC transformer to a different outlet so the control panel and radio/television are on different branch circuits, 3) Relocate the control panel with respect to the radio/television.

If necessary, the installer should consult an experienced radio/television technician for additional suggestions, or send for the "Interference Handbook" prepared by the Federal Communications Commission. This booklet is available from the U.S. Government Printing Office, Washington D.C. 20402, stock no. 004-000-00450-7.

The D2071A Control/Communicator is registered with the Federal Communications Commission under part 68, for connection to the public telephone network using an RJ31X or RJ38X jack installed by your local telephone company.

FCC Registration Number: AJ9USA-61104-AL-E
Ringer Equivalence: 0.0B (AC)
1.3B (DC)

Table of Contents

		Page
Section		
The D2071A Fire Control/Communicator		4
Introduction		4
Listings and Approval Information		5
D2071A Control/Communicator Assembly		8
Installation		9
Before You Begin		10
Terminal Block ③ ⑥ ⑦ ⑧ ⑨ ⑩ ⑪ ⑫ ⑬ ⑭ ⑮ ① ② ④ ⑤	Step 1: Earth Ground	11
	Step 2: Zone 1, Alarm Initiating Circuit	11
	Step 3: Zones 2 and 3, Supervisory Circuits	14
	Step 4: Initiating Circuit Alarm Relay	16
	Step 5: Phone Line Trouble Relay	17
	Step 6: Primary Power Supply	17
	Step 7: Secondary Power Supply and Charging Circuit	18
	Step 8: Telephone Connections	20
	Step 9: Cable Tie Installation	22
	Step 10: D2071A Mounting	22
	Step 11: End User Instruction Label	23
Programming		24
Receiver Reports		30
Trouble Shooting Guide		32
Specifications		36

Tables and Figures

	Page
Table 1: Mandatory Connections for NFPA 71 and NFPA 72 (Chap. 8)	7
Figure 1: D2071A Control/Communicator	8
Figure 2: Stand-Alone Installation	10
Figure 3: Slave Communicator Installation	10
Figure 4: Modes 1, 2, and 3	15
Figure 5: Relay Sockets	16
Figure 6: RJ31X Wiring	20
Figure 7: Insert the Cable Tie	22
Figure 8: Secure the Cable Tie and Wires	22

The D2071A Fire Control/Communicator

Introduction

The D2071A Fire Control/Communicator is a three zone digital alarm communicator transmitter (DACT) for use in limited stand-alone applications or for off-premises monitoring of existing fire alarm control panels (FACPs) in slave applications.

Zone 1 is a Class A (NFPA Style D) Alarm Initiating Circuit. It can be used to monitor waterflow or other alarm initiating devices in a stand-alone application, or to monitor an alarm output in a slave application. Zones 2 and 3 are Class B (NFPA Style A) Supervisory Circuits. They can be used to monitor sprinkler supervision devices such as valve tampers in a stand-alone application, or to monitor trouble outputs in a slave application.

Primary and alternate phone outputs enable the D2071A to communicate to the Central Station and/or Remote Station. A built-in phone line supervision circuit with trouble buzzer, LED, and optional Form C relay provides local phone line trouble annunciation for both phone lines. The D2071A also provides an optional Form C relay output for annunciation of alarms on the Alarm Initiating Circuit.

The D2071A is housed in a red plastic, non-conductive enclosure. The plastic enclosure insulates the product from surrounding circuit boards or metal surfaces. This allows you to mount the D2071A in fire alarm control enclosures listed for use with it. You can also install the D2071A in an economical, fire listed enclosure such as the Radionics D8109 or D4103R.

Communicator

The D2071A uses a built-in communicator to transmit reports to a digital receiver. It uses two RJ31X or RJ38X jacks to connect to two separate phone lines, for a primary and an alternate means of transmitting to the receiver. The D2071A has full phone line seizure, and complies with FCC regulations for using the public telephone network.

You must program two receiver phone numbers for the D2071A. The communicator first attempts to transmit reports to the primary phone number. If unable to transmit to the primary number, the communicator switches to the alternate number. It sends reports to the receiver in BFSK format or Pulsed Fast Single Round format. The communicator only accepts the 2300 Hz acknowledgment tone. It is compatible with most major digital receivers that accept the BFSK or Pulsed Fast Single Round formats and generate a 2300 Hz acknowledgment tone.

RFI/Lightning Protection

The D2071A resists radio frequency interference, and high voltage surges which are common to lightning areas. Spark gaps and M.O.V.s provide the D2071A with additional electrical protection.

Materials Included

D2071A

Radionics ships the D2071A Control/Communicator Panel completely assembled. The package includes: installation literature, an end user information label, two 5" double-sided adhesive strips, two mounting screws and washers, a strain relief cable tie, 32" dual connector battery leads, and two 1.8K Ω EOL resistors for the supervision circuits (zones 2 and 3).

D2071AC

You can purchase the D2071A in a D2071AC kit. The kit includes: installation literature, an end user information label, two mounting screws and washers, a strain relief cable tie, 32" dual connector battery leads, two 1.8K Ω EOL resistors for the supervision circuits (zones 2 and 3), a D4103R enclosure, two D161 phone cords, and two conduit support washers.

The D4103R in the kit comes with a D2002 Mounting Plate and a Basler Electric, model A9115, transformer (Radionics part number 58-06306-000) installed in the enclosure. This is a UL recognized, Class II transformer rated for 20 VA at 12 VAC. It uses pigtails to hard wire directly to a 110/120 VAC power source.

Materials Needed

Following is a list of additional parts necessary for installing the D2071A :

D126 Battery 12 V, 7 Ah battery required for NFPA 72 (Chapter 8) Remote Station stand-alone applications.

The battery must provide 60 hours of standby

plus five minutes of alarm operation.

Only use a battery in the 12 VAC mode.

D1219 Battery 12 V, 2.3 Ah battery for NFPA 71 Central Station applications only. The battery must provide 24 hours of standby. The D126 Battery is also acceptable for NFPA 71. Only use a battery in the 12 VAC mode.

D136 Relay (1 or 2) (Optional) One enables Phone Line Trouble Relay (K5).

One enables Initiating Circuit Alarm Relay (K6).

D161* or D162 Phone Cord (2) Primary and alternate phone line connections.

D1220 Transformer Use in the 12 VAC mode only.

D4103R*/D8109 Enclosure Or other UL listed fire enclosure.

(Optional)

D2002 Mounting Plate* To mount the D2071A in a D4103R enclosure.
(Optional)

D5100 Programmer or With the 2071 Product Handlers loaded.

D5200 Programmer

D8004 Transformer Enclosure Required for the D1220 transformer in commercial fire applications if D2071AC kit is not used.

* Included in the D2071AC kit. D4103R in kit includes hard-wired transformer.

Listings and Approval Information

Underwriters Laboratories lists the D2071A DACT (digital alarm communicator transmitter) under UL Standard 864 (Control Units Fire Signaling Systems) and 1635 (Digital Alarm Communicators) for Central Station Signaling Service (NFPA 71) and Remote Station Signaling Service (NFPA 72, Chapter 8). Install the D2071A in accordance with NFPA 70 (NEC Article 760).

Approvals are pending for Factory Mutual (FM), California State Fire Marshal (CSFM), and New York City Board of Standards and Appeals (NYCBSA).

Mandatory Connections

To comply with Central Station Fire (NFPA 71) or Remote Station (NFPA 72, Chapter 8) Signaling Service, connect the D2071A as described in Table 1. The Class A (NFPA Style D) and Class B (NFPA Style A) circuits shown are mandatory connections for slave and stand-alone applications. The *Installation* section contains detailed wiring instructions.

Slave Communicator Applications

To use the D2071A as a slave communicator to only provide signaling connections, connect the D2071A to an existing UL listed NFPA 71, 72 (Chapter 8), or 72 (Chapter 6) FACP. You can use the D2071A in compliance with NFPA standards in the following ways:

1. To provide NFPA 71 Central Station connections for an existing FACP when only a summary alarm and up to two trouble signals are required.
2. To provide NFPA 72 (Chapter 8) Remote Station signaling connections for an FACP listed for NFPA 72 (Chapter 8) .
3. To provide Central Station or Remote Station connections to an NFPA 72 (Chapter 6) Local FACP when required by the authority having jurisdiction.

Power for Slave Applications

For slave communicator applications connect the D2071A to a 24 VDC FACP (Fire Alarm Control Panel). Do not install a battery in this configuration. Do **NOT** connect the D2071A to a 12 VDC power supply or a control panel which only provides

12 VDC output. If the FACP does not provide a 24 VDC auxiliary power output, a D126 battery, a D1220 transformer, and a D8004 Transformer Enclosure are required. If you use the D2071AC kit, the Basler Electric, model A9115 (Radionics part number 58-06306-000), transformer installed in the D4103R enclosure replaces the D1220 transformer and the D8004 Transformer Enclosure. It is a UL recognized, Class II transformer rated for 20 VA at 12 VAC. It uses pigtailed wires to hard wire directly to a 110/120 VAC power source.

Listed Enclosure Required

Unless the monitored FACP is specifically listed or approved for use with the D2071A installed in the same enclosure, you must install the D2071A in a separate UL listed enclosure. Connect the separate enclosure to the FACP by conduit no more than 20 feet long. The Radionics D4103R, D8109, and D8108A are all suitable for this purpose. The D2071AC kit includes a D4103R with a Basler Electric, UL recognized, Class II, hardwire transformer rated for 20 VA at 12 VAC mounted in the enclosure. It uses pigtailed wires to hard wire directly to a 110/120 VAC power source.

Listings and Approval Information (Continued)

	Stand Alone Applications		Slave Applications	
	NFPA 72 Central Station	NFPA 72 Remote Station	NFPA 72 Central Station	NFPA 72 Remote Station
Primary Power 12 VAC * 24 VDC	① ② OK NO	OK NO	OK OK	OK OK
Battery Back-UP D126, 12 VDC, 7 Ah D1219, 12 VDC, 2.3 Ah	④ ⑤ OK OK	Required No	OK OK	Required No
Class A (Style D) Circuit ⑥ ⑦ ⑧ ⑨ Retard/Reset Time: (Waterflow Alarm ONLY)	Maximum of five waterflow switches or up to 100 mechanically activated initiating devices (heat detectors or manual pull stations). Not suitable for smoke detectors. Consult the appropriate standard or as allowed by the authority having jurisdiction.		Normally open dry alarm output contacts of an existing FACP. N/A	
Class B (Style A) Circuits Recommended Mode:	3	3	3	3
⑩ ⑪ ⑪ ⑫	Can monitor up to 20 valve supervisory switches per circuit. Mode 1 is not acceptable. Mode 2 is ONLY acceptable when a valve tamper device having ONLY a normally closed contact MUST be used and ONLY upon approval of the authority having jurisdiction.		Normally open dry trouble contacts of an existing FACP. Mode 3 recommended. Modes 1 and 2 are acceptable.	
Earth Ground	Yes		No	

Table 1: Mandatory Connections for NFPA 72 Central Station and NFPA 72 Remote Station

Receiving Equipment

The D2071A must report to compatible, UL listed receiving equipment that meets the following processing capabilities:

1. Fire Alarm
2. System Trouble
3. Low Battery
4. 24 Hour Test
5. System Restoral
6. 2300 Hz Acknowledgment Tone
7. Radionics BFSK or 3x1, 40 pulse per second, single round with parity (Radionics superfast)

D2071A Control/Communicator Assembly Enclosure

Size: 6.74" x 4.40" x 1.05"

Color: Red

Construction: UL94V-O flame rated, ABS plastic, non-conductive

The D2071A enclosure cover slides open approximately 2 inches to expose the terminal strip, the programming jack, and the two Form C relay sockets. There is no need to completely remove the cover during installation or for service.

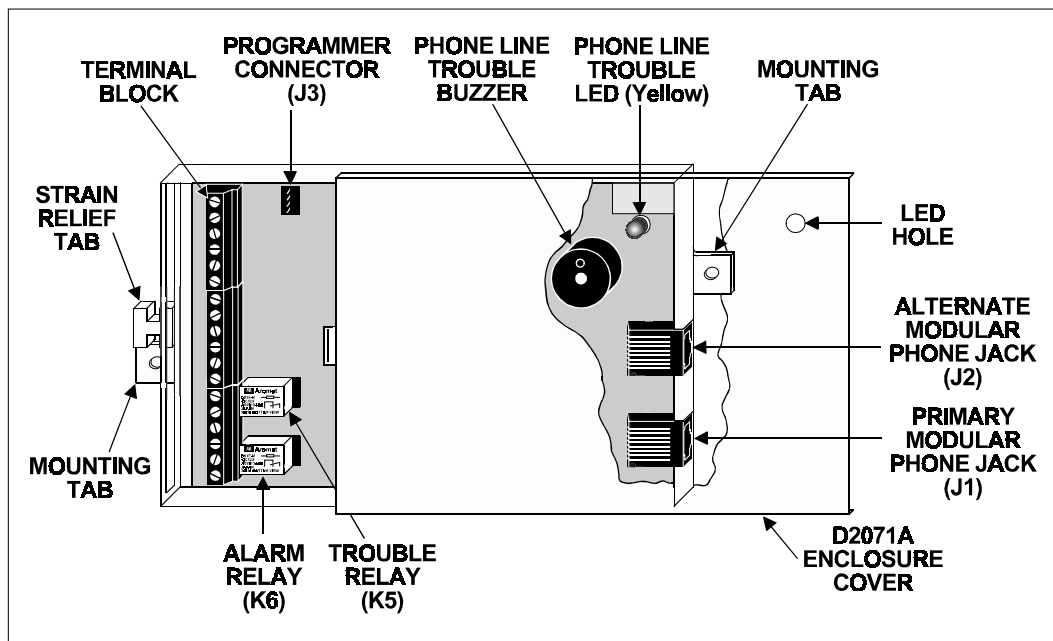

Figure 1: D2071A Control/Communicator

Phone Line Trouble Relay (K5)

Install a D136 Relay in this socket when using the optional Phone Line Trouble Relay (terminals 13 to 15). The relay activates when phone line trouble is detected on either the primary or secondary phone line, when communication failure occurs, and briefly upon power-up.

Initiating Circuit Alarm Relay (K6)

Install a D136 Relay in this socket when using the optional Initiating Circuit Alarm Relay (terminals 16 to 18). This relay activates when the initiating circuit is in an alarm condition.

Primary Modular Phone Jack

The primary phone jack connects the D2071A to the primary phone line for transmitting to the receiver.

Alternate Modular Phone Jack

The alternate phone jack connects the D2071A to an alternate phone line for transmitting to the receiver. If the D2071A fails to contact the receiver after two attempts on the primary line, it switches to the alternate line.

Phone Line Trouble Buzzer

The phone line trouble buzzer sounds when either the primary or the alternate phone line is in a trouble condition, or when communications failure occurs. Ten failed attempts to transmit any report puts the panel in communications failure. The phone line trouble LED and relay follow the activity of the buzzer.

The buzzer, LED, and relay are deactivated after a trouble condition on the phone line when the receiver acknowledges the phone line trouble report, or when the line returns to normal. If the D2071A attempts to transmit the phone line trouble report ten times without acknowledgment from the receiver, communication failure occurs.

If the D2071A is in communication failure, either the primary or alternate phone line must be detected as normal and a report acknowledged by the receiver before the buzzer is deactivated.

Phone Line Trouble (Phone Fail) LED (Yellow)

You can see the yellow LED through the top of the D2071A enclosure (upper right corner). The LED lights when the panel detects phone line trouble on either the primary or secondary phone line, when communication failure occurs, and briefly upon power-up.

Programmer Connector (J3)

Connect the D5100 or D5200 programmer to the Programmer Connector (J3).

Terminal Strip

The terminal strip connects system wiring for power, ground, a Class A (NFPA Style D) alarm initiating circuit, two Class B (NFPA Style A) supervisory circuits, and two Form C relay outputs.

Strain Relief Tab

The strain relief tab prevents unnecessary strain on connections to the D2071A. Secure all wire running from the D2071A to the tab using the enclosed cable tie.

Mounting Tabs

The mounting tabs located on each end of the D2071A provide a means of mounting the D2071A with screws. The adhesive strips provided can also be used to mount the D2071A.

Installation

(P) = Power Limited

(S) = Supervised

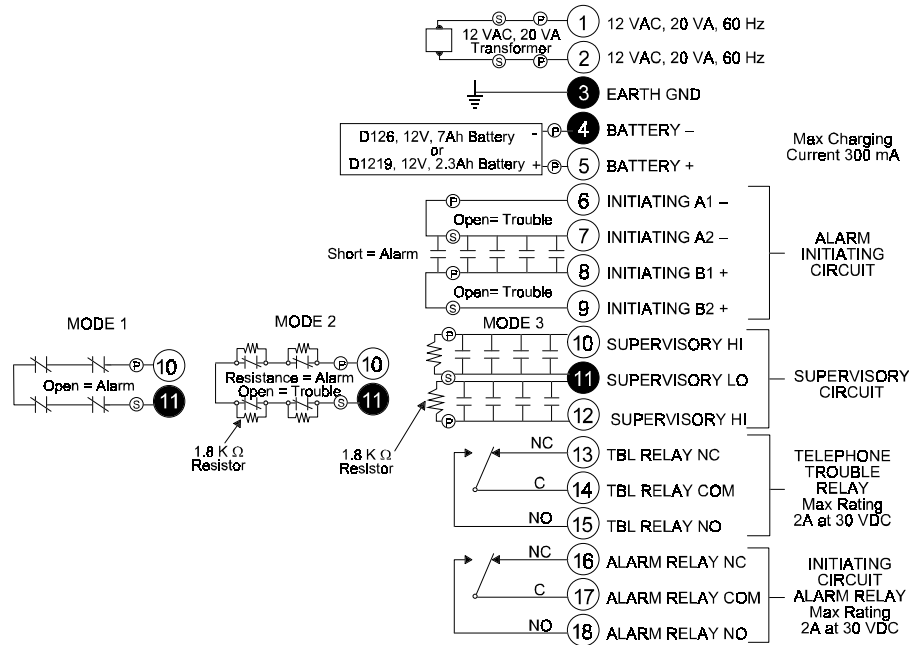

Figure 2: Stand-Alone Installation

(P) = Power Limited

(S) = Supervised

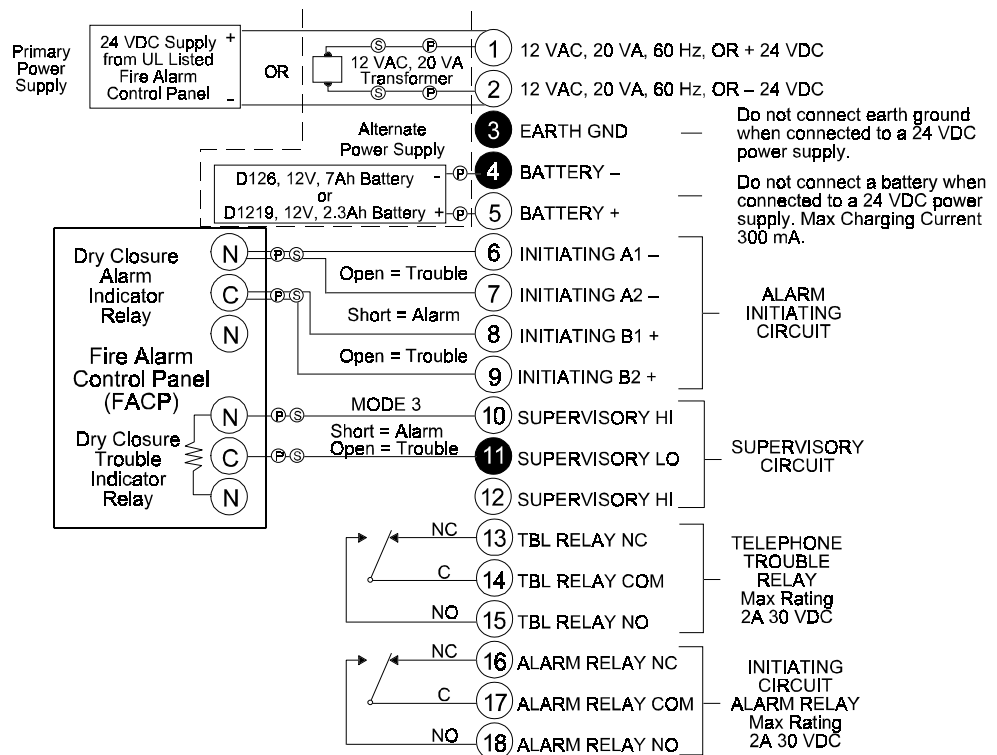

Figure 3: Slave Communicator Installation

Before You Begin

Follow the steps below to install the D2071A. Be aware that some terminals are wired differently for the stand-alone (Figure 2) and slave (Figure 3) applications.

Warning: If you are using the D2071AC kit, mount the D4103R enclosure and have a qualified electrician connect a 110/120 VAC power source to the black and white leads on the transformer. Be certain the power source is turned off before you begin the installation of the D2071A.

Step 1: Earth Ground Wiring

3

12 VAC Mode

To help prevent damage from electrostatic charges or other transient electrical surges, connect the D2071A panel to earth ground at terminal 3 before making any other connections to the panel. A grounding rod or cold water pipe are recommended earth ground references. Do not use telephone or electrical ground for the earth ground connection. Use 16 AWG wire when making the connection. Do not connect any other terminals to earth ground.

24 VDC Mode

When the D2071A is connected to the 24 VDC output of an FACP, do not connect terminal 3 to earth ground. Doing so may cause a continuous ground fault condition on the FACP.

Step 2: Zone 1, Alarm Initiating Circuit Description

6 7 8 9

Zone 1 is a 4-wire, Class A (NFPA Style D) initiating circuit. You can connect up to five waterflow alarm switches or up to 100 mechanically operated devices such as heat detectors or manual pull stations to this zone. NFPA 72 (Chapter 8) requires that you connect a single pull station with waterflow switches. The authority having jurisdiction may specify the location of this pull station. For other than this

exception, do not combine waterflow switches with other types of devices.

Unlike the two wire Class B (NFPA Style A) circuits that are supervised by end-of-line resistors, the double loop Class A (NFPA Style D) circuit provides alarm response from all initiating devices with a single open or ground fault condition on the circuit. Connect initiating devices to the D2071A as shown in Figures 2 and 3.

The D2071A has programmable retard (*Retard Time*) and reset (*Reset Time*) timers for waterflow alarm installations on wet pipe sprinkler systems. The timers compensate for water pressure surges and sprinkler alarm valve “fanning” conditions.

Class A(NFPA Style D) Circuit Parameters

Maximum resistance on the wiring for the sensor loops on the Class A (NFPA Style D) circuit is 100 Ω per loop (between A1 and A2 100 Ω maximum, between B1 and B2 100 Ω maximum).

To determine the electrical condition of the circuit, use a multimeter to measure the voltage across the terminal connections. The D2071A must be powered up and the loops in a normal condition. Connect one lead of the multimeter to a negative (-) terminal (6 or 7) and the other lead to a positive (+) terminal (8 or 9). The input voltages should be as follows:

Electrical Condition Multimeter Reading (measured zone input voltage)

Normal

$$\text{7} \text{ 8} = 1.0 - 1.9 \text{ VDC}$$

Alarm (Shorted)

$$\text{7} \text{ 8} = 0.0 - 0.3 \text{ VDC}$$

Retard and Reset Times

Only use the Zone 1 retard/reset feature for waterflow switches and/or controls without a retard/reset feature of their own.

The retard timer prevents false alarms from conditions such as water supply surges in wet pipe sprinkler systems. Surges may result in the brief activation of a waterflow alarm switch. The value you enter in the program item *Retard Time* determines the length of time that the waterflow switch must remain activated before an alarm report is initiated. Generally, a 15 second retard is adequate, but a longer interval may be necessary when extended surge conditions exist.

Reset Time is an additional program parameter that compensates for sprinkler alarm valve "fanning" conditions in wet pipe systems with unique hydraulic problems. Fanning occurs when a sprinkler head operates, or the inspector's test valve is opened, and the water flow switch does not remain activated long enough to overcome the retard time, but cycles between alarm and normal conditions.

The retard timer (*Retard Time*) and the reset timer (*Reset Time*) work together as follows.

- The retard timer (*Retard Time*) keeps track of the amount of time which the Alarm Initiating Circuit is in the alarm condition. It begins counting when the circuit enters the alarm condition.
- The reset timer (*Reset Time*) determines when the retard timer is reset to zero. When the Alarm Initiating Circuit enters a non-alarm (restored or trouble) condition, after being in the alarm condition, the retard timer stops at its current value and the reset timer starts counting.
- If another alarm condition is detected before the reset timer reaches the value you entered in *Reset Time*, the retard timer resumes counting from where it left off, and the reset timer is set to zero.
- If the amount of time specified in the *Retard Time* program item accumulates in one or more successive alarm activations, the D2071A transmits an alarm zone 1 report and activates the alarm relay.
- The retard timer resets to zero only when the circuit remains in a non-alarm condition (restored or trouble) for the amount of time entered in *Reset Time*.
- When the Alarm Initiating Circuit has been normal for the time in *Reset Time*, the D2071A sends a restoral zone 1 report.

Reset Time is typically set at half the *Retard Time*. If *Retard Time* were set at 15 seconds, *Reset Time* would be set at 7 or 8 seconds.

Wiring

Stand-Alone Applications

Connect the normally-open contacts of each waterflow switch (maximum of 5) or mechanically activated initiating device to the Alarm Initiating Circuit in parallel as shown in Figure 2.

Slave Communicator Applications

Connect the Alarm Initiating Circuit to an alarm indicator output (normally-open, dry closure) on the FACP (see Figure 3). Connect terminals 6 and 7 to the common contact, and terminals 8 and 9 to the normally-open contact. Program *Retard Time* and *Reset Time* for **0** seconds when connecting the Alarm Initiating Circuit to an existing FACP.

Step 3: Zones 2 and 3, Supervisory Circuits

10

11

12

Description

Zones 2 and 3 are Class B (NFPA Style A) circuits that can monitor sprinkler supervision devices such as valve tamper (maximum of 20 per circuit) in stand-alone applications. In slave communicator applications these circuits monitor the trouble outputs of an associated FACP.

You can wire the Class B (NFPA Style A) circuits in three different ways, Mode 1, 2, or 3. Program item *Class B Mode* determines the mode for both zones 2 and 3. Wire both circuits for the same mode configuration. Connect dry contact devices to the Supervisory Circuits in series (normally-closed), or in parallel (normally-open). Install a 1.8K Ω resistor at the end of the Class B (NFPA Style A) circuits if needed (see Figure 4).

Mode 1 has only two status conditions, alarm and normal. Modes 2 and 3 have three status conditions, alarm, trouble, and normal. The D2071A transmits an alarm report for a trouble condition when you use a Mode 1 or Mode 2 circuit to monitor an FACP trouble output or sprinkler valve tamper.

Mode 1 and Mode 2 Restrictions

You can NOT use Mode 1 for sprinkler supervision (stand-alone) in NFPA 71 Central Station or NFPA 72 (Chapter 8) Remote Station installations. Mode 3 is recommended. Only use Mode 2 when a normally closed contact valve tamper device must be used, and only upon approval of the authority having jurisdiction. For more information concerning Modes and NFPA requirements, refer to the *Listings and Approvals* section in the front of this manual.

Wiring

Stand-alone Applications

Connect supervision devices (maximum of 20 per circuit) such as valve tamper switches to terminals 10 and 11 (Zone 2) or 11 and 12 (Zone 3) as shown in Figure 4. Don't forget to program item *Class B Mode* for the wiring configuration you use. There should be no more than 100 Ω resistance on the sensor loops for the Class B (NFPA Style A) circuits.

Slave Communicator Applications

When connecting the D2071A to an FACP, use the Mode 3 configuration for slave communicator applications (see Figure 4). Connect terminals 10 and 11 (Zone 2) or 11 and 12 (Zone 3) to the trouble outputs (dry closure) on the FACP. Connect terminal 10 or 12 to the normally-open contact, and terminal 11 to the common contact. Install a 1.8K Ω resistor between the normally open and normally closed contacts. You must program *Class B Mode* for Mode 3.

Class B (NFPA Style A) Circuit Parameters

To determine the electrical condition of the Class B (NFPA Style A) Supervisory Circuits, use a voltmeter to measure the voltage across the terminal connections (refer to Figure 4 for loop voltages). The loop must be connected, and the D2071A must be powered.

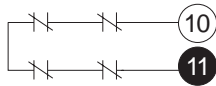

MODE 1

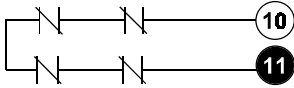

The loops are configured for NC devices only. No EOL resistor is used. The loops are not supervised for troubles. Mode 1 is not acceptable for stand-alone applications.

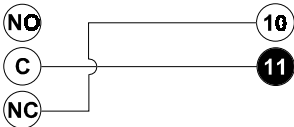

- Normal: 0.0 - 1.5 VDC
- Alarm (Open): 1.8 - 13.0 VDC

MODE 2

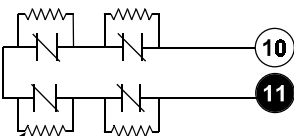

A 1.8K Ω EOL resistor is used across each NC device in the series loops. Mode 2 is acceptable for NFPA 72 Central Station and Remote Station Stand-alone applications only when a NC valve tamper device must be used and only upon approval of the authority having jurisdiction.

1.8K Ω Resistor

- Normal: 0.0 - 1.5 VDC
- Alarm (Resistance): 1.8 - 9.0 VDC
- Trouble (Break): 9.3 - 13 VDC

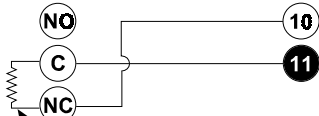

A single off-normal device puts the loops into alarm. A broken circuit or multiple off-normal devices put the loops into trouble (unless the loop was previously in alarm).

1.8K Ω Resistor

MODE 3

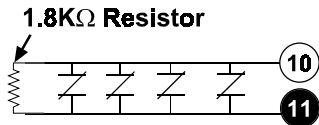

A 1.8K Ω EOL resistor is used at the end of the loops. Trouble reports are sent on an open circuit. Mode 3 is required for sprinkler supervision in NFPA 72 Central Station and Remote Station slave applications or for trouble reports from the FACP. It is the recommended mode for 72 Central Station slave applications.

1.8K Ω Resistor

- Normal: 1.9 - 5.8 VDC
- Alarm (Closed): 0.0 - 1.7 VDC

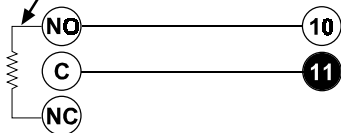

Figure 4: Modes 1, 2, and 3

Step 4: Initiating Circuit Alarm Relay Description

①⑥ ①⑦ ①⑧

Install a D136 relay in socket K6 to use the optional Initiating Circuit Alarm relay. The D136 provides a Form C dry contact, rated at 2 A maximum current at 30 VDC (power from independent supply). The relay activates (reverse state) when the Class A (NFPA Style D) Alarm Initiating Circuit (Zone 1) goes into an alarm condition. It deactivates when the circuit restores to normal. Terminal 17 is the relay common, terminal 16 is normally-closed, and terminal 18 is normally-open. In a normal state, terminals 16 and 17 have continuity. When activated, terminals 17 and 18 have continuity.

Relay Installation

Install a D136 Relay into socket K6 (labeled ALARM RELAY) as follows.

1. Slide back the D2071A cover to expose the socket as shown in Figure 5.
2. The D136 relay has two pins on one side and three pins on the other side. Place the relay into socket with the pins oriented as shown in Figure 5. You can install the relay flush left or right.

Wiring

Connect only low voltage power sources and devices to terminals 16, 17, and 18. Do not use the D2071A's standby battery to provide a power output for the circuit.

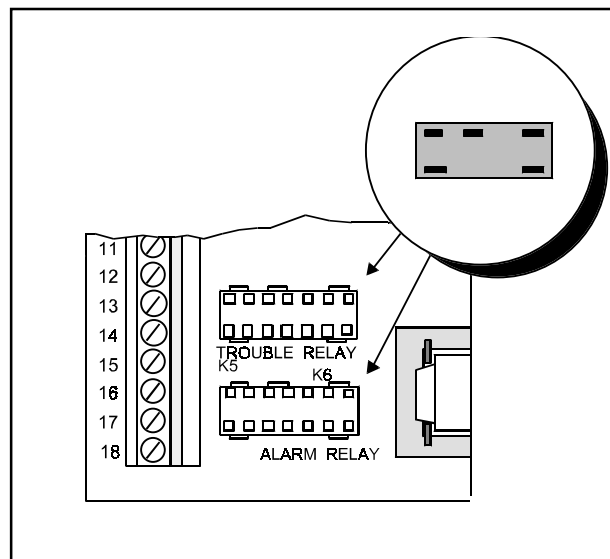

Figure 5: Relay Sockets

Step 5: Phone Line Trouble Relay Description

13 ⑭ ⑮ ○

Install a D136 relay in socket K5 to use the optional Phone Line Trouble relay. The D136 provides a Form C dry contact, rated at 2 A maximum current at 30 VDC (power from independent supply). The relay activates (reverse state) when a faulted condition appears on either the primary or alternate phone lines or when a communication failure occurs.

The Phone Line Trouble Relay activates whenever the Phone Line Trouble Buzzer sounds. Refer to *Phone Line Trouble Buzzer* in the *D2071A Control/Communicator Assembly* section for more information on relay activation and restoral.

Relay Installation

Install a D136 Relay into socket K5 (labeled TROUBLE RELAY) as follows:

1. Slide back the D2071A cover to expose the socket as shown in Figure 5.
2. The D136 relay has two pins on one side and three pins on the other side. Place the relay into socket with the pins oriented as shown in Figure 5. You can install the relay flush left or right.

Wiring

Terminal 14 is the relay common, terminal 13 is normally-closed, and terminal 15 is normally-open. In a normal state, terminals 13 and 14 have continuity. When activated, terminals 14 and 15 have continuity.

Only connect low voltage power sources and devices to terminals 13, 14, and 15. Do not use the D2071A's standby battery to supply power for the circuit. In some slave communicator applications the Phone Line Trouble Relay (terminals 13-15) on the D2071A can be connected to a trouble zone input on the FACP.

Step 6: Primary Power Supply

① ②

You can power the D2071A Control/Communicator using a 12 VAC, 20 VA transformer and standby battery, **OR** you can connect it to the 24 VDC output of an FACP. Either method can be used for NFPA 71 or 72 (Chapter 8) applications. **DO NOT** connect the D2071A to a 12 VDC power supply of an existing FACP. In such cases, use the transformer and battery for 12 VAC mode.

Parallel Activation on Power Up: The Phone Line Trouble Buzzer, Relay, and LED activate briefly upon AC or battery power up, indicating panel is operational.

12 VAC Mode

Connect a 12 VAC, 20 VA transformer to terminals 1 and 2 using 18 AWG stranded wire (maximum length 50 ft.). Commercial fire applications require the D8004 transformer enclosure for the D1220 transformer or the D2071AmC kit.

Warning: The hardwire transformer mounted in D4103R enclosure included in D2071AC kit replaces the D1220 transformer. Be certain the 110/120 VAC power source is turned off when you connect the black and white transformer leads to the source. Connect the yellow leads from the transformer to terminals 1 and 2.

Program the *12 Volt Mode* program item "Yes". See *Step 7* for battery installation instructions. NFPA 71 applications require the 110/120 VAC, 60 Hz commercial power for the transformer be unswitched and from a reliable source. NFPA 72 (Chapter 8) applications require a dedicated branch circuit to supply the 110/120 VAC power for the transformer. The means of being disconnected for the circuit must only be available to authorized personnel, and identified as a "Fire Alarm Control Circuit."

Never share the transformer with other equipment: Foreign grounds on the AC input damage the D2071A's power circuit.

Important!

24 VDC Mode

Connect a 24 VDC, uninterrupted, regulated, auxiliary output from an FACP to terminals 1 and 2. Set program item *12 Volt Mode* to "No". Terminals 1 (+) and

2 (-) are polarity protected when the D2071A is programmed for the 24 VDC mode.

Do not connect a 12 VDC standby battery and do not connect earth ground to the D2071A when it is in 24 VDC mode.

The discharge/recharge schedule below shows the voltages at terminals 1 and 2 that generate battery reports with the D2071A in 24 VDC mode. If the voltage falls below 11.1 VDC, the D2071A is not operational.

24 VDC - Battery Discharge/Recharge Schedule*

Source supervised is the 24 VDC input from FACP

(Terminals 1 and 2 of the D2071A)

Discharge Cycle		Recharge Cycle	
27.6 volts	-	FACP Battery float voltage	AC On - FACP Battery recharging begins
21.8 volts	-	Battery trouble report (TROUBLE ZN 9)	24.7 volts - Battery restoral report (RESTORAL ZN 9)
11.1 volts	-	Disable	27.6 volts- FACP Battery charged

* Actual voltage may vary \pm 5%

Step 7: Secondary Power Supply and Charging Circuit



(12 VAC Mode Only)

If you are installing the D2071A in 24 VDC Mode, skip this step and go to *Step 8: Telephone Connections*.

Battery

The D2071A charging circuit is only calibrated for lead-acid type batteries. Do not connect the D2071A to a battery when it is using 24 VDC from an existing FACP. The battery supplies power for the system during interruptions in primary (AC) power in the 12 VAC mode.

For NFPA 72 (Chapter 8) applications, you must use a 12 VDC, 7 Ah, sealed, lead-acid, rechargeable battery (Radionics model D126)

For NFPA 71 applications use a 12 VDC, 2.3 Ah, sealed, lead-acid, rechargeable battery (Radionics model D1219). The Radionics model D126 exceeds the standby requirements and is also acceptable.

Battery Installation

Install the battery in an upright position at the base of the metal enclosure. Connect the negative side of the battery (black) to D2071A terminal 4 with the black lead provided with the D2071A. Connect the positive side of the battery (red) to D2071A terminal 5 with the red lead.

Parallel Activation on Power Up: The Phone Line Trouble Buzzer, Relay, and LED activate briefly upon AC or battery power up, indicating panel is operational.

Replacement

Battery (Continued)

Radionics recommends battery replacement every 3 to 5 years under normal use. Do not install the transformer into a power source that is routinely switched off. This does not comply with NFPA standards and causes heavy discharges of the battery which may result in premature failure.

Battery Supervision

During an AC power loss, the battery supplies all power to the D2071A. In doing so, the battery slowly discharges. When the battery voltage drops below 11.8 VDC, the D2071A sends a TROUBLE ZN 9 report to the receiver.

After the AC is restored, the battery begins to charge. At 13.4 volts the D2071A sends a battery restoral report, RESTORAL ZN 9.

Restoral Zn 9 Exceptions: If a battery is not connected to the D2071A when AC power is connected, the panel still sends a RESTORAL ZN 9 report to the receiver. A RESTORAL ZN 9 is also sent after the programmer is disconnected from the D2071A.

Battery Charging Circuit

The D2071A charges the battery with a float charge circuit. Maximum charging current is 300 mA. The Battery Discharge/Recharge Schedule shows voltages during the discharge/recharge cycle.

12 VAC - Battery Discharge/Recharge Schedule*

Source supervised is the battery connected to the D2071A

Discharge Cycle

- 13.8 volts - Battery float voltage
- 11.8 volts - Battery trouble report (TROUBLE ZN 9)
- 8.5 volts - Disable all processing and memory functions (deep battery discharge can occur below this level)

Recharge Cycle

- AC On - Battery recharging begins
- 9.0 volts - Battery trouble report (only if battery discharged below 8.5 volts)
- 13.4 volts - Battery restoral report (RESTORAL ZN 9)
- 13.8 volts - Battery charged

* Actual voltage may vary by as much as $\pm 5\%$

Step 8: Telephone Connections

Telephone Cord Installation

Connect the primary phone line to the D2071A modular Jack "J1" using a D161 or D162 phone cord. Connect the alternate phone line to the D2071A modular Jack "J2" using another D161 or D162 phone cord.

You must connect separate primary and alternate phone lines to the D2071A for all applications.

Location

To prevent jamming of alarm and other reports, wire and locate the RJ31X or RJ38X jack so that normal phone use is temporarily interrupted while the communicator transmits data (see Figure 6). After installation, confirm that the D2071A seizes the line, acquires dial tone, and reports correctly to the receiver.

Telephone Line Supervision

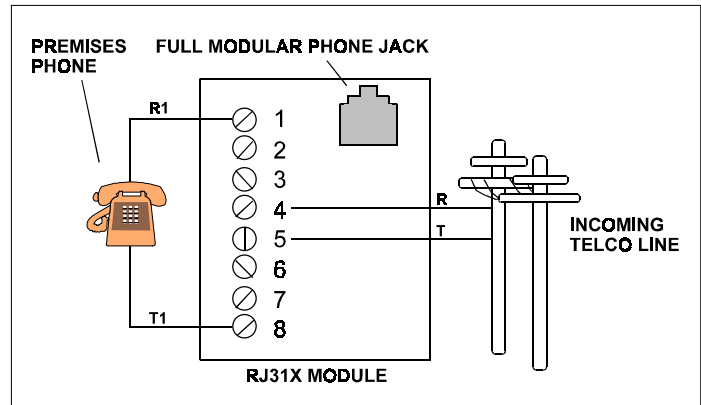

Figure 6: RJ31X Wiring

The D2071A monitors both the Primary and Alternate telephone lines while the communicator is idle by "sniffing" the line for trouble. Phone line trouble is defined as line voltage below 10 VDC and current less than 10 mA. Total time for trouble indication is 210-240 seconds. If there is a report to transmit, the D2071A does not "sniff" the phone lines until the report is transmitted or a communication failure occurs. The D2071A reports a faulted condition on the Primary phone line as a `TROUBLE ZN B` and the Alternate phone line as a `TROUBLE ZONE C`.

Each line is "sniffed" once a minute if both lines are good. If a line is determined to be in trouble, the D2071A steps up the test rate and "sniffs" once every ten seconds. If the trouble still exists after 15 samples (150 seconds), the panel sends a trouble report and activates the buzzer, Phone Fail LED, and Phone Line Trouble Relay (if installed). See *Step 5: Telephone Trouble Relay* for installation instructions.

The buzzer, LED, and relay are deactivated after a trouble condition on the phone line when the receiver acknowledges the phone line trouble report, or when the line returns to normal. If the D2071A attempts to transmit the phone line trouble report ten times without acknowledgment from the receiver, communication failure occurs.

If the D2071A is in communication failure, either the primary and alternate phone lines must be detected as normal and a report acknowledged by the receiver before the buzzer, LED, and relay are deactivated. Refer to the *Troubleshooting Guide* for help in finding the cause of phone line problems.

The buzzer, light, and relay may remain activated for up to 24 hours if the communications failure was not due to trouble conditions detected on the phone lines, and no other report is transmitted before the next scheduled test report.

Call Routing

After one failed attempt to transmit a report, the D2071A attempts to transmit a `TROUBLE ZN E` report, in addition to the original report. After two failed attempts to reach the receiver, the

Telephone Line Supervision (Continued)

D2071A switches from the primary to the alternate phone line. The D2071A switches and makes a dialing attempt even if you haven't programmed an alternate phone number.

The D2071A continues alternating between the primary and alternate lines for a total of ten attempts. If the D2071A cannot make contact with the receiver after 10 attempts, it goes into communications failure, and activates the Phone Fail LED, Phone Line Trouble Buzzer, and Phone Line Trouble Relay (if installed).

Total time from the first attempt to communications failure is up to ten minutes. A **RESTORAL ZN E** is the only report transmitted after a communications failure. Any report in the D2071A's buffer prior to communications failure is not transmitted. The buffer is cleared.

For all applications you must program both a primary and an alternate phone number. The numbers must be different.

Attempt	Routing
1	Phone Number 1 Primary Line
2	Phone Number 1 Primary Line
3	Phone Number 2 Alternate Line
4	Phone Number 1 Alternate Line
5	Phone Number 2 Primary Line
6	Phone Number 1 Primary Line
7	Phone Number 2 Alternate Line
8	Phone Number 1 Alternate Line
9	Phone Number 2 Primary Line
10	Phone Number 1 Primary Line

Notification

Do NOT connect registered equipment to party lines or coin operated telephones. If the local telephone company requests notification before you connect the D2071A to the telephone network, supply the following information:

- 1) the particular line you are connecting the panel to,
- 2) the make, model, and serial number of the device, and
- 3) the FCC registration number (AJ9USA-61104-AL-E) and ringer equivalence (0.0B = AC, 1.3B = DC).

If the telephone company makes changes in its communications facilities, equipment, operations, or procedures that may affect the performance of the communicator, the phone company is obligated to notify the user in writing.

Step 9: Cable Tie Installation

After making all of the necessary connections, secure all wire coming out of the D2071A to the Strain Relief Tab. Follow the procedure below.

1. String the cable tie through the middle of the "H" shaped Strain Relief Tab.
2. Bunch the wires attached to the D2071A together (see Figure 7). Make sure none of them become disconnected.
3. Wrap the cable tie around the wires and firmly secure the tie to the Strain Relief Tab (see Figure 8).

Step 10: D2071A Mounting

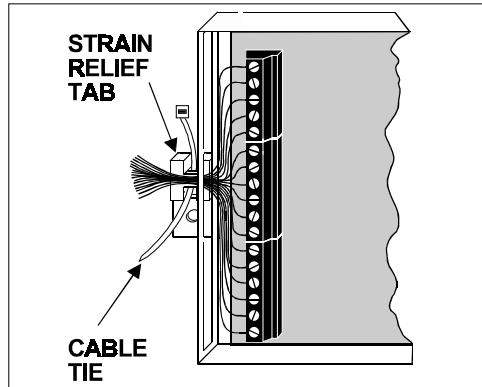

Figure 7: Insert the Cable Tie

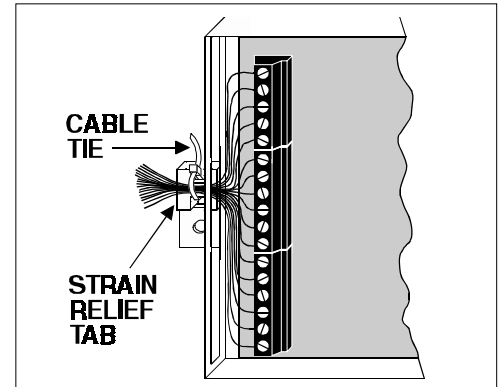

Figure 8: Secure the Cable Tie

You can mount the D2071A inside a UL listed fire enclosure of appropriate size or, as the D2071A enclosure is non-conductive, in the same enclosure with an existing FACP. Unless the monitored FACP is specifically listed or approved for use with the D2071A installed in the same enclosure, you must install the D2071A in a separate UL listed enclosure.

When installing the D2071A in the same enclosure with an existing FACP, leave room on the bottom of the enclosure for the battery. Do not mount the D2071A in a location where it restricts the flow of cooling air to the FACP power supply or similar device.

When mounting the the D2071A in a separate UL listed enclosure such as the D4103R or D8109. Connect the enclosure to the FACP by conduit (not to exceed 20 feet). The D2071A can be mounted in the enclosure using any of the methods below.

Screw Mounting

1. Determine the mounting location in the enclosure.
2. Position the D2071A in the desired location.
3. Using a pencil, mark the location of the mounting tab holes.
4. Drill appropriate size holes (1/8" for the screws provided).
5. Mount the D2071A using two screws. Two #8 screws and washers are provided.

D2002 Mounting Plate

The D2002 Mounting Plate is used to mount the D2071A in a D4103R enclosure. It is installed

in the enclosure provided with the D2071AC kit. Follow the procedure below to install the D2071A with the D2002 mounting plate.

1. Secure the mounting plate to the four stand-offs in the D4103R enclosure with the four #6 screws provided with the mounting plate.
2. Mount the D2071A to the mounting plate using the two #8 screws provided with the D2071A.

Adhesive Strip Mounting

The two adhesive strips provided can be used to mount the D2071A in the enclosure with the FACP or in a separate enclosure. Choose a location with a smooth, clean, and dry mounting surface.

1. Turn the D2071A over to show the back of the enclosure.
2. Remove the protective backing from one side of a 5" adhesive strip.
3. Press the strip firmly to the back of the D2071A near the top edge.
4. Remove the protective backing from one side of the other 5" adhesive strip.
5. Press the strip firmly to the back of the D2071A near the bottom edge.
6. Bend back or remove any tabs in the enclosure that may prevent the D2071A from being securely mounted.
7. Remove the remaining protective backing from the adhesive strips.
8. Attach the D2071A to the enclosure by pressing it firmly into the desired location.

Step 11: End User Instruction Label

An end user label is included for use when the D2071A is connected to an FACP. As the D2071A does not have any end user serviceable parts, the label instructs the user to call for service if they cannot silence the D2071A from the FACP. Affix this label in a location easily seen by the end user. The front of the FACP enclosure is an ideal location.

Programming

The D2071A is programmed with either the D5100 Bar Code Programmer or

D2071A Programming

Using the D5200 Programmer

Description

This section provides a brief operation overview of the D5200 Programmer. It is not intended to be a substitute for the *D5200 Operation Manual* (74-06176-000). You should be familiar with the *D5200 Operation Manual* before attempting to program any Radionics Product.

To program the D2071A DACT with the D5200 Programmer, make sure the programmer contains the 2071 Product Handler Program. See the *D5200 Programmer Operation Manual* for D5200 update instructions.

Navigating Through Handlers and Program Records

Access program items by navigating through “groups” of the programmer. Use the red *ENTER GROUP* and *EXIT GROUP* keys to move in and out of each group (see Figure 9).

Use the red up ↑ and down ↓ arrow keys to scroll through the list of items at each group. Scroll through a list of available product handlers at the Product Handler Group. See saved record titles at the Record Group, and program items are at the Program Item group.

Use the red left ← and right → arrow keys to move the cursor horizontally within one line of the LCD display.

Figure 9 shows an example of how to use navigational keys to move through the 2071 program. Use these keys the same way for all product handlers.

Function Keys

Six function keys simplify the use of the programmer.

ON The red *ON* key switches the programmer on. This key does not power down the programmer. Switch the D5200 off by selecting 5200 OFF in the PRODUCT HANDLERS menu, or it will power down automatically after the programmed Time Out time has elapsed.

HELP The red *HELP* key switches the programmer into help mode. See the *D5200 Operation and Installation Manual* for more information.

CANCEL Use the red *CANCEL* key to undo changed items if you have not yet accepted the change by pressing the white *ENTER* key.

CLEAR The red *CLEAR* key erases unENTERed or ENTERED program item data, and replaces it with blank spaces.

RECV (COPY) The red *RECV (COPY)* key moves a copy of the record in the attached product to the D5200 Programmer.

SEND (LOAD) The red *SEND (LOAD)* key moves a copy of the record in the D5200 Programmer to a product you are programming.

Data Keys

The white keys on the keyboard are used for data entry.

Helpful Tones

The D5200 Programmer emits four distinct sounds, which notify the user of key presses, data acceptance/rejection, and system errors.

Click A short, sharp click occurs every time you press a key. The programmer does *not* click when you press the **ON**, CAP LOCK, and SHIFT keys.

Pip A short, single frequency tone sounds when you press the white **ENTER** key and the D5200 accepts the change.

Tweedle A quick series of pips indicating that you pressed an invalid key or made an inappropriate entry.

Buzz A sour, flat tone indicates a system error. Examples of typical system errors follow:

- A product is not connected to D5200 when you try to copy or load it.
- The D5200 is notifying you of a low battery condition.
- The D5200 announces that it will automatically count down and then turn off.
- You are attempting to delete a record or handler.
- You are entering into a product handler which contains a TIMEOUTSAVE record. The TIMEOUTSAVE record was saved by the D5200 when the it automatically turned off to save power.

Editing a Record

To make changes to an existing **2071** record:

1. Scroll to the **2071** product handler from the Product Handlers menu using the red ↓ or ↑ keys, and press the red **ENTER GROUP** key.
2. Scroll to the appropriate record title using the red ↓ or ↑ keys, and press the red **ENTER GROUP** key.
3. Scroll to the appropriate program item using the red ↓ or ↑ keys, and edit the entry. Press the white **ENTER** key to enter the new data.
4. Press the red **EXIT GROUP** key to exit from the record. The **SAVE** display appears if changes have been made to any program item entries in the record.

Programmer Connection

To access the four-pin Programmer Connector (J3), slide back the cover on the D2071A. The Programmer Connector is next to terminal 1 (see Figure 1). The D2071A is ready for programming after connecting it to the programmer. It is not necessary to reset the D2071A before loading to, or copying from the panel.

Programming before installing the phone lines may sound the buzzer: You can program the D2071A prior to installation. However, if the D2071A is powered and not connected to a phone line, the phone fail buzzer sounds after approximately ten minutes. Power down the unit to silence the buzzer.

Program the Radionics D2071A using the Radionics D5200 Programmer containing the **2071** Product Handler. Before programming the D2071A, we recommend that

you read and become familiar with this section of the manual.

Entering the 2071 Handler

1. Starting at *PRODUCT HANDLERS*, press the red ↓ until the cursor is on *2071* Press the red **ENTER GROUP** key.
2. The cursor appears on the *NEWRECORD* prompt. Press the red **ENTER GROUP** key.
3. The D5200 displays *Account #*.

Program Modules

Unlike larger Radionics products, the *2071* Product Handler does not group Program Items in *Program Modules*. You are in the Program Item Level as soon as you enter the *2071* program.

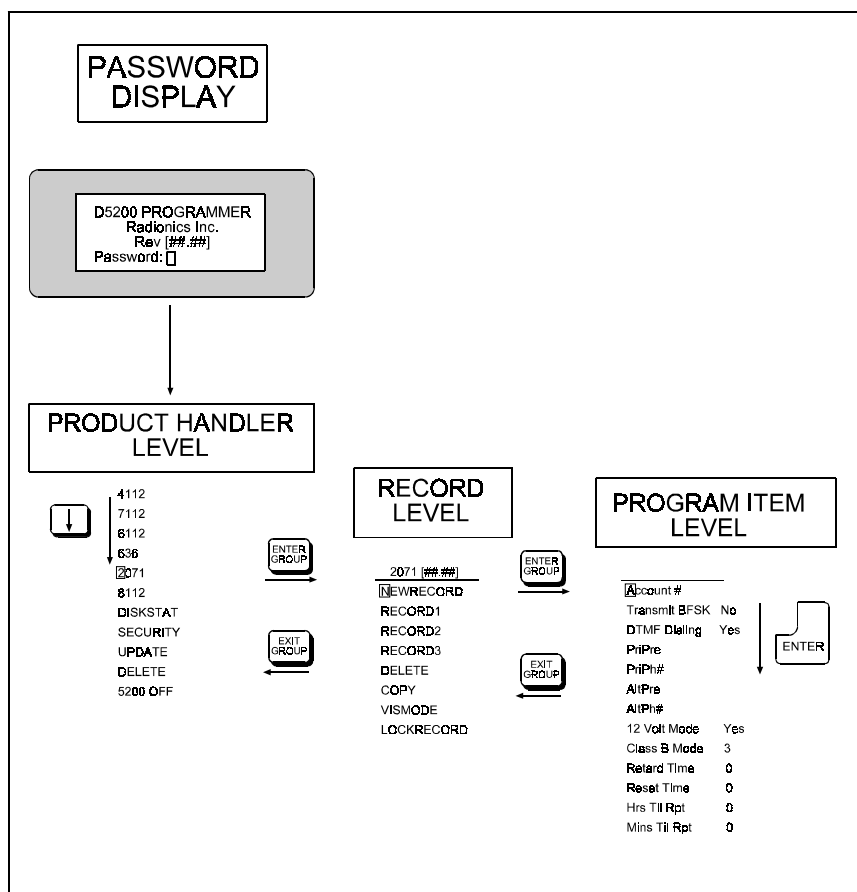

Figure 9: Navigating the 2071 Program

How to Edit the Program Record

Each D2071A DACT programming option (Program Item) is listed with a *Display* and a *Default* (as they appear in the programmer display), a set of *Selections*, and a *Description*.

The Selections are the only entries available for a particular Program Item. For instance, the Program item *Account #* can only use 0 through 9, B through F, or no entry. **Do not use unlisted entries.**

To edit program items, change the entry and press the white **ENTER** key. If the entry is valid, the programmer moves the cursor to the next prompt. When you have edited all the Program Items in the record, the programmer returns you to the first program item in the record.

Exiting the 2071 program: You can exit from any point within the program. To exit the 2071 program, press the **EXIT GROUP** key until the D5200 Programmer displays

PRODUCT HANDLERS.

2071 Program

This record selects several functions of the D2071A DACT, including the account number used to identify the location during communication, how it will dial the phone number, how the D2071A will be powered, and loop response times.

Account #

Default: Blank
Selections: 0 - 999, BBB - FFF,
or Blank

All entries should be right justified. Blank Entry = No account number (sends 000 in pulse, sends nothing in BFSK).

Transmit BFSK

Default: Yes
Selections: Yes or No

Program the receiver reporting format.

Yes ----- Transmit in **BFSK** format with 2300 Hz acknowledgment.

No ----- Transmit in fast, single round, expanded pulsed format with a checksum digit and 2300 Hz acknowledgment.

DTMF Dialing

Default: Yes
Selections: Yes or No

Yes ----- Dual Tone Multi-Frequency **Dialing** of the telephone numbers

No ----- Pulse dialing

PriPre

Default: Blank
Selections: 0 - 9, B - F,
or Blank

Prefix for the **Primary** receiver telephone number . Enter up to nine characters.

Blank ---- No prefix/area code. A delay of up to 7 seconds is automatically inserted in front of the prefix.

See Table: *Special Dialing Characters* for other selections.

PriPh#

Default: Blank
Selections: 0 - 9, B - F,
or Blank

Primary receiver tele**Ph**one number. Enter up to seven characters

See Table: *Special Dialing Characters* for other selections.

Primary and alternate phone numbers **MUST** be programmed, and the primary number **MUST** be different from the alternate phone number.

Special Dialing Characters		
Selection	Affect on Dialing	Comments
B	(*) Character	Used in accessing special telephone features.
C	Three second pause	Inserts a pause between digits while dialing.
D	Seven second dial tone wait	Waits up to seven seconds for a dial tone before dialing.
E	(#) Character	Used in accessing special telephone features.
F	Changes from rotary to DTMF or vice versa	Use when accessing some long distance carriers while using rotary-dial phone lines

Table 2: Special Dialing Characters

AltPre

Default: Blank

Selections: 0 - 9, B - F,
or Blank

Prefix for the **Alternate** receiver telephone number. Enter up to nine characters.

Blank ---- No prefix/area code . A delay of up to 7 seconds is automatically inserted in front of the prefix.

See Table: *Special Dialing Characters* for other selections.

AltPh#

Default: Blank

Selections: 0 - 9, B - F,
or Blank

Alternate receiver tele**Ph**one number. Enter up to seven characters.

See Table: *Special Dialing Characters* for other selections.

Primary and alternate phone numbers **MUST** be programmed, and the alternate number **MUST** be different from the primary phone number.

12 Volt Mode

Default: Yes

Selections: Yes or No

Enable **12** or **24 Volt** operation **Mode**.

Yes ----- 12 VAC, 20 VA, 60 Hz transformer operation

No ----- 24 VDC supply from an existing fire panel

Class B Mode

Default: 3

Selections: 1 - 3

Program the **mode** of operation for the **Class B** (NFPA Style A) Supervisory Circuits (Zones 2 and 3).

1----- Mode 1: Not acceptable for stand-alone applications.

2----- Mode 2: Restricted use for stand-alone applications.

3----- Mode 3 : Required for most stand-alone applications.

For detailed mode specifications refer to the *Supervisory Circuit* installation instructions.

Retard Time

Default: 0

Selections: 0 - 90

Program the **Retard Timer** for the Class A (NFPA Style D), Alarm Initiating Circuit (Zone 1). Enter the number of seconds for the retard time. After the alarm condition is detected on the sensor loops, the retard timer is started. An alarm report is not transmitted until the retard timer reaches the value entered in **Retard Time**. If the faulted condition restores before the retard timer reaches the value entered in **Retard Time**, the alarm report is not transmitted. For a more detailed explanation of the retard timer, see the *Zone 1, Alarm Initiating Circuit* installation instructions.

Consult the appropriate NFPA Standard or the local authority having jurisdiction for acceptable retard times.

Reset Time

Default: 0

Selections: 0 - 90

Program the **Reset Timer** for the Class A (NFPA Style D), Alarm Initiating Circuit (Zone 1). Enter the number of seconds for the reset time. The circuit must be in a non-alarm (restored or trouble) condition for the number of seconds entered here before the retard timer is set to zero. For a more detailed explanation of the reset timer, see the *Zone 1, Alarm Initiating Circuit* installation instructions.

Hrs Til Rpt

Default: 0

Selections: 0 - 25

Number of **Hours** un**Til** the first test **Report** is sent. Program the number of hours from when the panel is powered up, or reset with the programmer, to when the first test report is sent. If this entry and *Min Til Rpt* are both left defaulted at 0, the first test report is sent in 12 hours and all subsequent reports are sent at 24 hour intervals thereafter.

Mins Til Rpt

Default: 0

Selections: 0 - 59

Number of **Minutes** un**Til** the first test **Report** is sent. Program the number of additional minutes the first test report is delayed over and above the hours programmed in *Hrs Til Rpt*.

Test Timer Default Delay: When the unit is powered up the first test occurs 12 hours later unless you program a delay in *Hrs Til Rpt* and/or *Mins Til Rpt*.

Receiver Reports

ALARM ZN 1:

A closure or short between the two loops of the Class A (NFPA Style D) Alarm Initiating circuit. This report is delayed by the time specified in *Retard Time* (for waterflow alarm applications only).

ALARM ZN 2:

Mode 1: Open on the Class B (NFPA Style A) Supervisory circuit, terminals 10 and 11.

Mode 2: Resistance on the Class B (NFPA Style A) Supervisory circuit, terminals 10 and 11.

Mode 3: Closure or short between terminals or a ground fault on the positive (+) side of the Class B (NFPA Style A) Supervisory circuit, terminals 10 and 11.

ALARM ZN 3:

Mode 1: Open on the Class B (NFPA Style A) Supervisory Circuit, terminals 11 and 12.

Mode 2: Resistance on the Class B (NFPA Style A) Supervisory Circuit, terminals 11 and 12.

Mode 3: Closure or short between terminals or a ground fault on the positive (+) side of the Class B (NFPA Style A) Supervisory Circuit, terminals 11 and 12.

RESTORAL ZN 1:

The Class A (NFPA Style D) Alarm Initiating circuit returned to normal from an alarm or trouble condition. This report is delayed by the time specified in *Reset Time* when the circuit restores from an alarm condition.

RESTORAL ZN 2:

All modes: Trouble or Alarm condition on Zone 2 has cleared.

RESTORAL ZN 3:

All modes: Trouble or Alarm condition on Zone 3 has cleared.

RESTORAL ZN 9:

12 VAC Mode: This report is transmitted after AC power is restored, the panel has been programmed, or the battery is changed or recharged.

24 VDC Mode: This report is transmitted when DC power input is applied, when the DC power input reaches 27.6 VDC after falling below 24.3 VDC, or after programming the panel.

RESTORAL ZN B:

Primary phone line restored.

RESTORAL ZN C:

Alternate phone line restored.

RESTORAL ZN E:

Normal test timer activation.

TROUBLE ZN 1:

A break or ground on either loop of the Class A (NFPA Style D) Alarm Initiating circuit (no retard time applies).

TROUBLE ZN 2:

Mode 1: Not available.

Mode 2: Class B (NFPA Style A) circuit, terminals 10 and 11, open.

Mode 3: Class B (NFPA Style A) circuit, terminals 10 and 11, open.

TROUBLE ZN 3:

Mode 1: Not available.

Mode 2: Class B (NFPA Style A) circuit, terminals 11 and 12, open.

Mode 3: Class B (NFPA Style A) circuit, terminals 11 and 12, open.

TROUBLE ZN 9:

12 VAC Mode: Low Battery.

24 VDC Mode: DC power input less than 24.3 volts.

TROUBLE ZN B:

Open or short on primary phone line.

TROUBLE ZN C:

Open or short on alternate phone line.

TROUBLE ZN E:

Communications failure after ten attempts to transmit a report. Reports in the D2071A's buffer when communications failure occurs are not transmitted. The buffer is cleared.

or

Test timer failed to report on the first attempt.

or

When received in the same transmission (phone call) with another report, a TROUBLE ZN E indicates the other report(s) in the transmission did not get through on the first attempt.

Troubleshooting Guide

Introduction

Radionics provides this guide to help you troubleshoot problems with the D2071A. To prevent problems from occurring, read the preceding sections of this manual and verify that the panel is correctly installed and programmed.

Phone Line Trouble Buzzer, LED, and Relay Activated

There are two basic conditions, phone line trouble and failure to communicate (communications failure), that activate the phone line trouble buzzer, LED, and relay.

Phone Line Trouble

If the phone line trouble buzzer, LED, and relay activate or if a TROUBLE ZN B or TROUBLE ZN C is received, follow the procedure outlined below.

1. Verify that the cords for both lines are correctly connected to the RJ31X or RJ38X jacks and the D2071A.
2. Verify that the RJ31X or RJ38X jacks are wired correctly. The incoming phone line must be wired to terminals 4 and 5. The in-house phone system must be wired to terminals 1 and 8.
3. Verify that all telephones are on hook and not on hold. Some telephone company systems automatically drop the voltage and current when phones are left off hook for extended periods. Usually placing the phone on hook restores the phone line.

If after completing the steps above, the phone line is not restored, meter the phone lines for first for voltage and then current. You should meter at least 20 VDC when the D2071A is idle ("on hook"). If the voltage is below 20 VDC, meter for current. There should be at least 10 mA of current on the line. If your readings are below the minimum values, contact your telephone company repair service.

Communications Failure

Communications failure occurs after ten unsuccessful attempts to reach the receiver. Follow the *Phone Line Trouble* procedure to verify that there is no problem with the phone lines at the D2071A installation. If the phone lines are good, monitor the lines (preferably at the receiver) for one of the symptoms listed below.

Symptom: The line rings but the receiver does not pick up.

1. Verify that the lines are correctly connected to the receiver.
2. Verify that correct prefixes and phone numbers for the receiver have been programmed into the D2071A.

Symptom: The D2071A reaches a busy signal for all ten attempts to reach the receiver.

1. Verify that correct prefixes and phone numbers for the receiver have been programmed into the D2071A.
2. The receiver's call load may be too great. Additional phone lines may be needed for the receiver.
3. Verify that the phone lines are not shorted between the phone company's equipment and the receiver by placing a call to the number for the receiver. If you hear the line ring, but the ring detector doesn't light, or if you hear a busy signal and the green on line (OL) indicator is not lit, call the phone company for service.

Communications Failure (continued)

Symptom: The receiver answers the call and provides an acknowledgment tone, but the communicator does not transmit its reports.

1. Verify that the receiver is producing a 2300 Hz acknowledgment tone.

Symptom: The receiver answers the call and provides an initial “handshake” acknowledgment tone, but does not acknowledge the D2071A's report transmission with a “kiss-off” acknowledgment tone.

1. Verify that the receiver is compatible with the format the D2071A is using (either BFSK or Radionics Superfast). See *Transmit BFSK* in the *Program Entry Guide* in this manual.
2. Noisy phone lines may be interfering with report transmission. Try making a voice call on the line to verify the noisy condition. It may be necessary to have the phone company check the lines.

Trouble Zone E

See TROUBLE ZN E in the Receiver Reports section for the causes of this report. If TROUBLE ZN E reports regularly accompany other reports check the following:

1. After two attempts to reach the receiver, a DS9471 switches to the alternate phone line for the third attempt. Verify that the primary phone is a DTMF line.
2. If the DS9471 is programmed for DTMF dialing and you have verified that it is connected to DTMF phone lines, try programming it for pulse dialing. The local phone company may not be compatible with the dialing speed of the DS9471.
3. The DS9471 may be getting a busy signal at the first dialing attempt. The receiver's call load may be too great. Additional phone lines may be needed for the receiver.
4. Noisy phone lines may be interfering with report transmission. Try making a voice call on the line to verify the noisy condition. It may be necessary to have the phone company check the lines.
5. Verify that Zone 1 Style D initiating circuit is normal. See *Step 2: Zone 1, Alarm Initiating Circuit*.
6. Verify that Zones 2 and 3 Style A supervisory circuits are normal. See *Step 3: Zones 2 and 3, Supervisory Circuits*.
7. If using the 24 Volt Mode, test terminals 1 and 2 for proper input voltage. See *Step 6: Primary Power Supply, 24 Volt Mode*.
8. If using 12 Volt Mode, test Terminals 1 and 2 for proper input voltage. See *Step 6: Power Supply, 12 VAC Mode*.
9. If using the 12 Volt Mode, test the battery for proper float voltage. See *Step 7: Secondary Power Supply and Charging Circuit (12 Volt Mode Only), Battery Lead Supervision (12 Volt Mode Only)*.
10. Make sure the battery leads are connected and not corroded. See *Step 7: Secondary Power Supply and Charging Circuit (12 Volt Mode Only), Battery Lead Supervision (12 Volt Mode Only)*.

Problems Programming with the D5200 Programmer

Before attempting to program the D2071A, be certain the 2071 Product Handler is loaded in the programmer. You should also be familiar with the basic operation of the programmer. See the *D5200 Operation Manual* (74-06255-000). If you still experience problems, check for the symptoms below.

Symptom: After pressing SEND LOAD, the programmer displays *Plug in 2071*.

1. Verify the D5206 adapter is securely plugged into the D2071A.
2. Verify the D5203 programmer cord is securely plugged into the D5206 adaptor.
3. Verify the D5203 programmer cord is plugged into the COMMUNICATOR port on the programmer.
4. Verify the D2071A is connected to the appropriate power supply.

Problems with the Zones (Alarm Initiating and Supervisory Circuits)

Symptom: Zone 1 (Alarm Initiating Circuit) does not go into alarm.

You must maintain a short between loop A (terminals 6 and 7) and loop B (terminals 8 and 9) for at least the time programmed in *Retard Time*.

Symptom: Zone 1 (Alarm Initiating Circuit) does not restore immediately after an alarm.

The circuit must remain normal for at least the time programmed in *Reset Time*.

Symptom: Zone 1 (Alarm Initiating Circuit) remains in trouble or alarm with all devices connected to the circuit normal.

An open or ground on the circuit causes a trouble report. Remove the circuit loops from the D2071A and meter them for continuity. There should be no more than 100 Ω resistance between the wires that connect to terminals 6 and 7 and between the wires that connect to terminals 8 and 9.

With the wires for the circuit loops still removed from the D2071A, meter them for continuity to ground.

Symptom: Zone 2 or 3 (Supervisory Circuits) remains in trouble or alarm with all devices connected to the circuit normal.

1. Verify that the circuit is wired for the mode you chose in the *Class B Mode* program item.
2. Copy the program from the D2071A to verify the *Class B Mode* program item is programmed correctly.
3. An open on the circuits causes a trouble report for modes 2 and 3, and an alarm report for mode 1. A ground can cause an alarm report for modes 2 and 3.

Remove the circuit loops from the D2071A and meter them for continuity. There should be no more than 100 Ω plus the value of the resistors in the circuit between the wires that connect to terminals 10 and 11 or between the wires that connect to terminals 11 and 12.

With the wires for the circuit loops still removed from the D2071A, meter them for continuity to ground.

Trouble Zone 9

A TROUBLE ZN 9 report tells you there is a problem with the battery when the D2071A is in 12 VAC mode or a problem with the power supply in the 24 VDC mode. Check for the following:

12 VAC Mode (Battery and Transformer)

1. Verify that there is at least 12 VAC on terminals 1 and 2.
2. The outlet the transformer is plugged into should meter between 110 and 120 VAC.
3. Verify that the output for the transformer connected to terminals 1 and 2 is rated for 12 VAC and at least 20 VA.
4. Disconnect the transformer from terminals 1 and 2 and meter the battery at terminals 3 and 4. A fully charged battery should show 13.8 volts.
5. Make sure the battery is a 12 V sealed lead acid type. It should be rated at 2.3 or 7 Ah or greater, depending on the NFPA classification of the installation.

24 VDC Mode (Connection to FACP)

1. Verify that there is 27.6 VDC on terminals 1 and 2.
2. Verify that earth ground is NOT connected to terminal 3.
3. Verify that there is NOT a battery connected to terminals 4 and 5.
4. Verify that program item 12 Volt Mode is set to no.

Specifications

Power Input:

12 VAC, 20 VA with 12 VDC battery
24 VDC

Operating Current:

	12 VAC Mode Average/Communicating	24 VDC Mode
Idle Current:	29.5 mA	30.0 mA
Battery Charging:	51.0 mA	N/A
Alarm w/ Relay:	50.0 / 110 mA	61.0 / 115 mA
Alarm w/o Relay:	31.5 / 79.0 mA	32.0 / 80.0 mA
Phone Trouble w/ Relay:	82.0 / 120.0 mA	84.5 / 140 mA
Phone Trouble w/o Relay:	54.0 / 110 mA	55.5 / 110 mA
Alarm and Trouble w/Relay:	110 / 160 mA	140 / 170 mA
Alarm and Trouble w/o Relay:	55.5 / 102 mA	58.0 / 140 mA

Minimum Panel Operation Voltage:

8.5 VDC in 12 V Mode
11.1 VDC in 24 V Mode

Phone Voltage:

Minimum: 20 VDC
Normal: 48-52 VDC

Zone 1 Voltage:

Multimeter in parallel with normal loop terminals 6 and 7 (-) and normal loop terminals 8 and 9 (+).

Normal: 1.92 VDC
Alarm: 0.3 VDC
Open: N/A

Response Time: 0.2 to 90 sec. depending on Retard/Reset time.

Operating Temperature:

32° - 120° F
0° - 73° C

Enclosure:

Color: Red
Size: 7.8" x 4.4" including mounting tabs
Material: Non-conductive plastic
ABS UL94V-O

Zones 2 and 3 Voltage:

Multimeter in parallel with normal loop terminals 10 and 11 (Zn 2), 11 and 12.(Zn 3)

Mode 1

Normal: 0.0 VDC
Alarm (Open): 1.8 VDC
Response Time: Approx. 2-4 seconds

Mode 2

Normal: 0.0 VDC
Alarm (Resist.): 1.8 VDC
Trouble (Break): 9.3 VDC
Response Time: Approx. 2-4 seconds

Mode 3

Normal: 5.8 VDC
Alarm (Closed): 1.7 VDC
Trouble (Open): 10.3 VDC
Response Time: Approx. 2-4 seconds

Wire Specifications:

Refer to NEC, NFPA 70, Article 760 for wire specifications.

D1220 Transformer Wiring Distances	
18 AWG	250 Feet maximum
16 AWG	375 feet maximum
14 AWG	600 feet Maximum
12 AWG	1,000 feet maximum

